

PN# F-3418

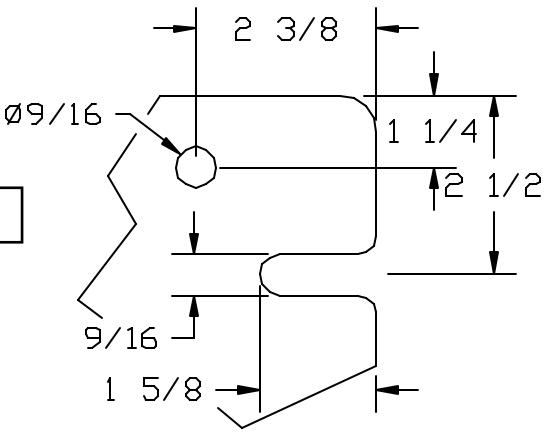

CORNER DETAIL

