

© DEN HARTOG INDUSTRIES, INC.

Copyright. All information furnished within this document, electronic file or design correspondence is the property of Den Hartog Industries, Inc. and shall not be used, disclosed to others or copied without the expressed written consent of Den Hartog Industries, Inc.

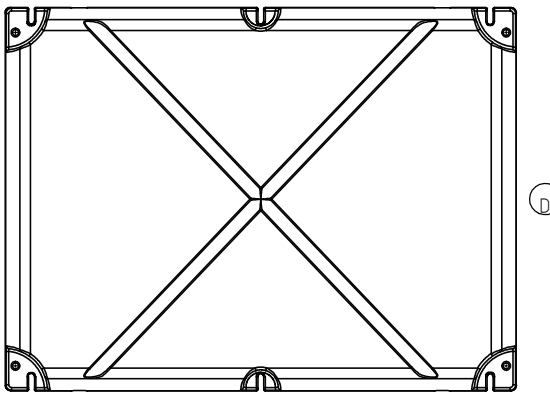
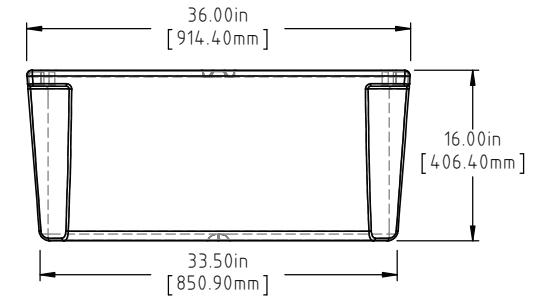
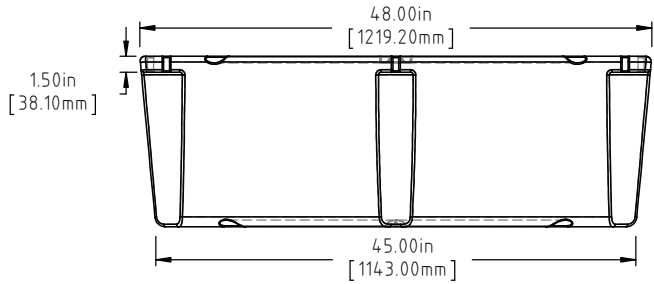
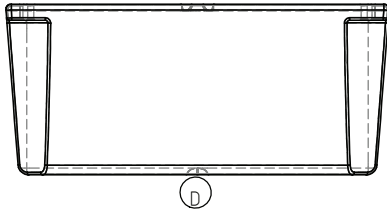
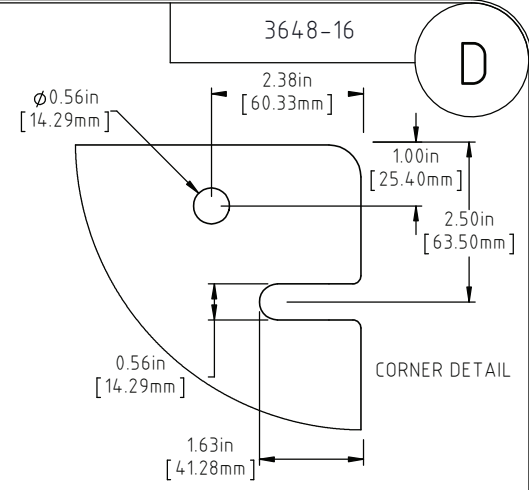
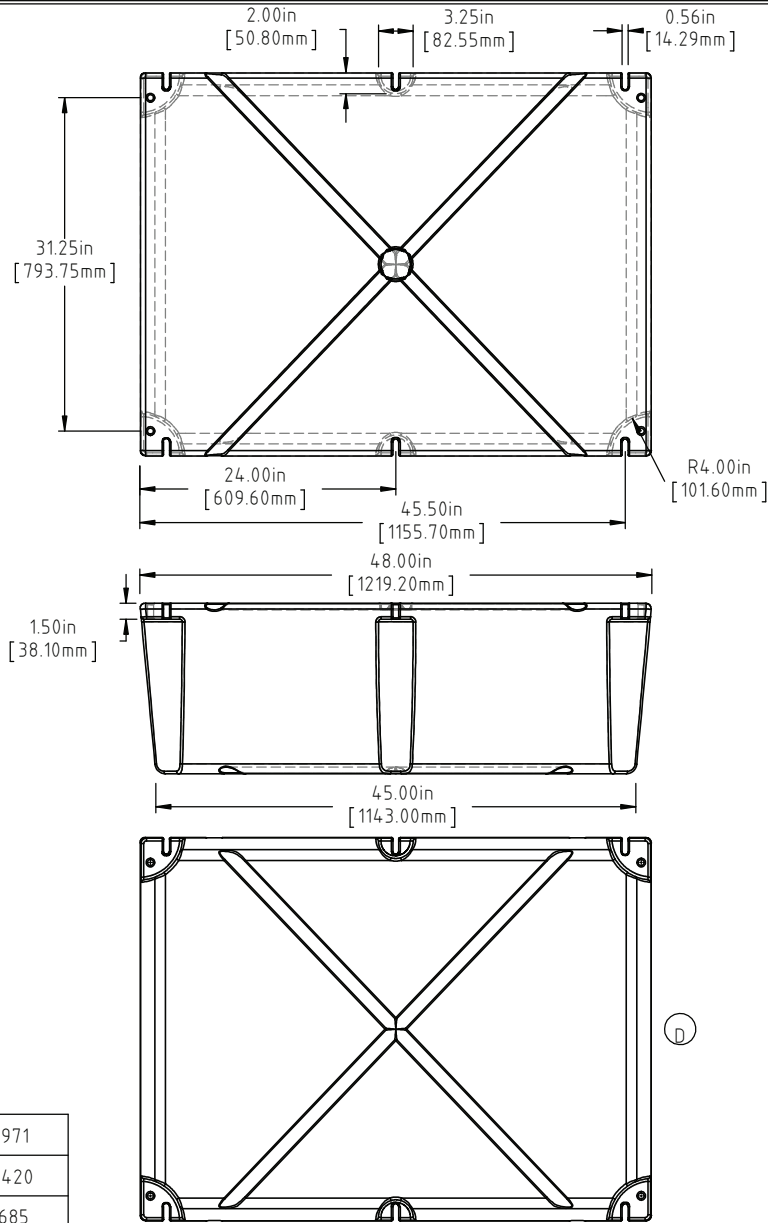

D	BOTTOM AND SIDE VIEWS ADDED TO PRINT	ADH 12/4/14	2971
C	874 LBS WAS 656 LBS	ADH 6/21/12	2420
B	METRIC DIMENSIONS ADDED	ADH 6/16/08	1685
A	ADD BUOYANCY NOTE	GWC 1/8/07	
A	CHANGE WEIGHTS AF WAS 33 FF WAS 54	GWC 1/8/07	
1	CHANGE WEIGHTS	11/18/94	
REV	DESCRIPTION	BY / DATE	CCN

DRAWN / DATE DHJ 3/15/94	MATERIAL  POLYETHYLENE
APPRD. / DATE ADH 11/5/07	

ALL DIMENSIONS ARE IN DECIMAL INCHES  
TOLERANCES UNLESS OTHERWISE SPECIFIED  
POLYETHYLENE  
±1% @ 68°F

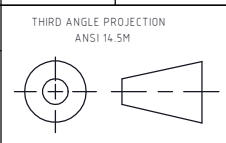

SHOT WEIGHT: 36 LBS.(16.33 KG.)	NOTES: (A) 1.) AF 36 LBS.(16.33 KG.) 2.) FF 51 LBS.(23.13 KG.) 3.) 0.150 IN (3.81 mm) NOM. WALL
SHIPPING WEIGHT: SEE NOTES	
FINISH:	

(A)(C)  
NOTE: BUOYANCY IS 874 LBS.(396.44 KG)



**Den Hartog**  
INDUSTRIES, INC.

Ace Roto-Mold Injection Molding Blow Molding Sowjoy

4010 HOSPERS DRIVE S. BOX 425, HOSPERS, IOWA 51238-0425

DESCRIPTION	36 X 48 X 16 FLOAT	
SCALE	N.S.	PART NO. 3648-16